

KEITH PANEL SYSTEMS

D E T A I L S

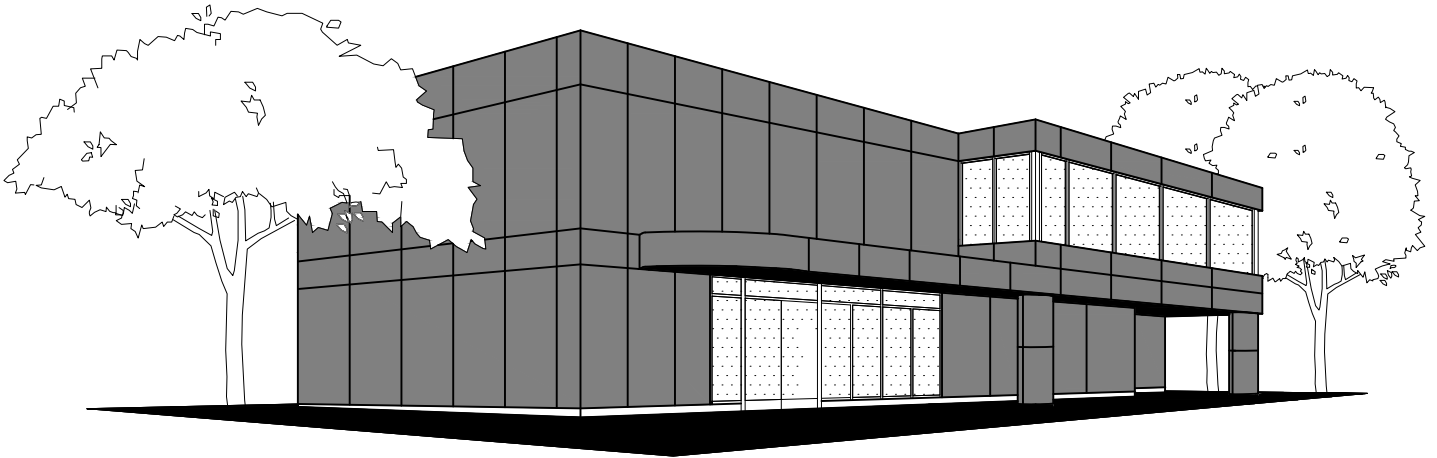

SYSTEM -A- EDGE

KEITH PANEL SYSTEMS

SYSTEM DETAILS

****THIS MANUAL IS PROVIDED FOR INFORMATION PURPOSES ONLY****

THE DETAILS SHOWN IN THIS DRAWING PACKAGE ARE NOT INTENDED TO REPLACE PROJECT SPECIFIC SUBMITTAL DRAWINGS, AND ARE SUBJECT TO CHANGE AT ANY TIME. ANY USE OF THESE DRAWINGS OR INSTALLATION OF THE SYSTEM SHOWN IN THESE DRAWINGS SHALL EXCLUSIVELY BE AT THE RISK OF THE PARTIES INVOLVED IN SUCH USE OR INSTALLATION, AND EACH OF SUCH PARTIES ASSUMES ANY AND ALL SUCH RISKS. BY USING THESE DRAWINGS/DETAILS IN ANY WAY, YOU ACKNOWLEDGE AND AGREE THAT YOU HAVE READ AND UNDERSTAND THIS LEGAL NOTICE.

GENERAL NOTES

1. KPS IS NOT RESPONSIBLE FOR INFORMATION SHOWN ON ALL DETAILS BEYOND KPS SPECIFIC SCOPE OF WORK.
2. DETAILS OF ADJACENT WORK ARE SHOWN FOR COMPLETENESS ONLY. THE PROJECT ARCHITECT/ PROJECT ENGINEER/ THE CONTRACTOR SUPPLYING AND/OR INSTALLING THE STRUCTURAL SUPPORT IS RESPONSIBLE FOR ITS DESIGN/ INSTALLATION TO ACCOMMODATE ALL LOADS IMPOSED UPON IT BY OUR PRODUCTS.
3. OUR ENGINEERING IS LIMITED TO THE LOAD CARRYING COMPONENTS OF THE PANEL SYSTEM AND ITS FASTENERS SHOWN ON THESE SHOP DRAWINGS.
4. OUR COMPANY POLICY IS TO IMPROVE AS WE PROGRESS, THEREFORE, THE DETAILS IN THIS MANUAL MAY IMPROVE OR CHANGE AS APPROVED BY CONSULTANTS.
5. THESE DRAWINGS SHALL REMAIN THE PROPERTY OF KEITH PANEL SYSTEMS CO. LTD. THIS DOCUMENT SHALL NOT BE REPRODUCED OR USED FOR ADDITIONS OR ALTERATIONS WITHOUT THE PRIOR WRITTEN CONSENT OF KEITH PANEL SYSTEMS CO. LTD.
6. JOINT CAULKING: IF REQUIRED. DOW CWS RECOMMENDED. (NOTE SHOP DRAWINGS FOR LOCATIONS.)
7. WEEP HOLES: 1/4" DIAMETER HOLES. 2 HOLES—ONE AT EACH END ON HORIZONTAL AND VERTICAL PANELS.
8. INTERACTION BETWEEN DISSIMILAR MATERIALS (IE. ALUMINUM TO GALVANIZED STEEL) MUST BE SEPARATED (IE. SHIMS OR SEPARATION TAPE).
9. ADJACENT SUBTRADES TO LEAVE MINIMUM 6" FLAP OF AIR/VAPOUR BARRIER TO TIE IN WITH KPS. SIMILIARLY KPS WILL LEAVE 6" FLAP TO TIE IN WITH ADJACENT SUBTRADES WHICHEVER COMES FIRST.

TYPICAL PANEL CLIP LAYOUT

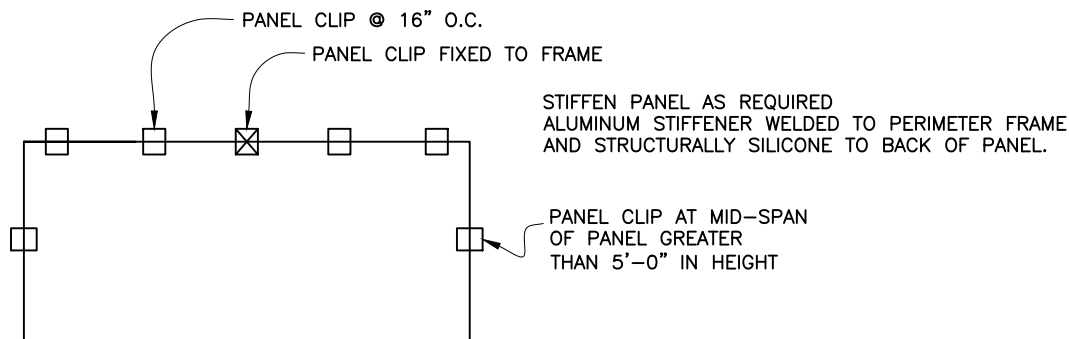

KPS_GENERIC_2_MOD_PC

KEITH PANEL SYSTEMS

SYSTEM DETAILS

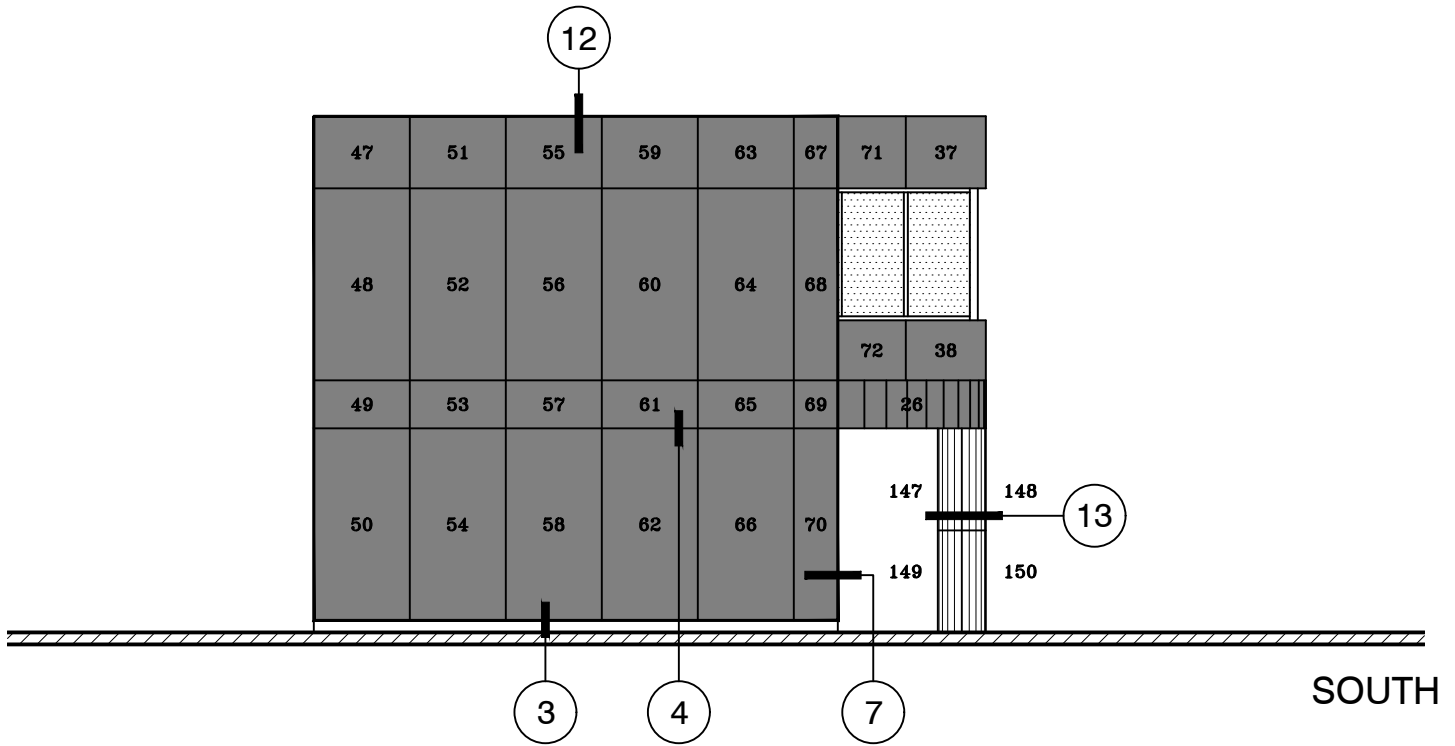
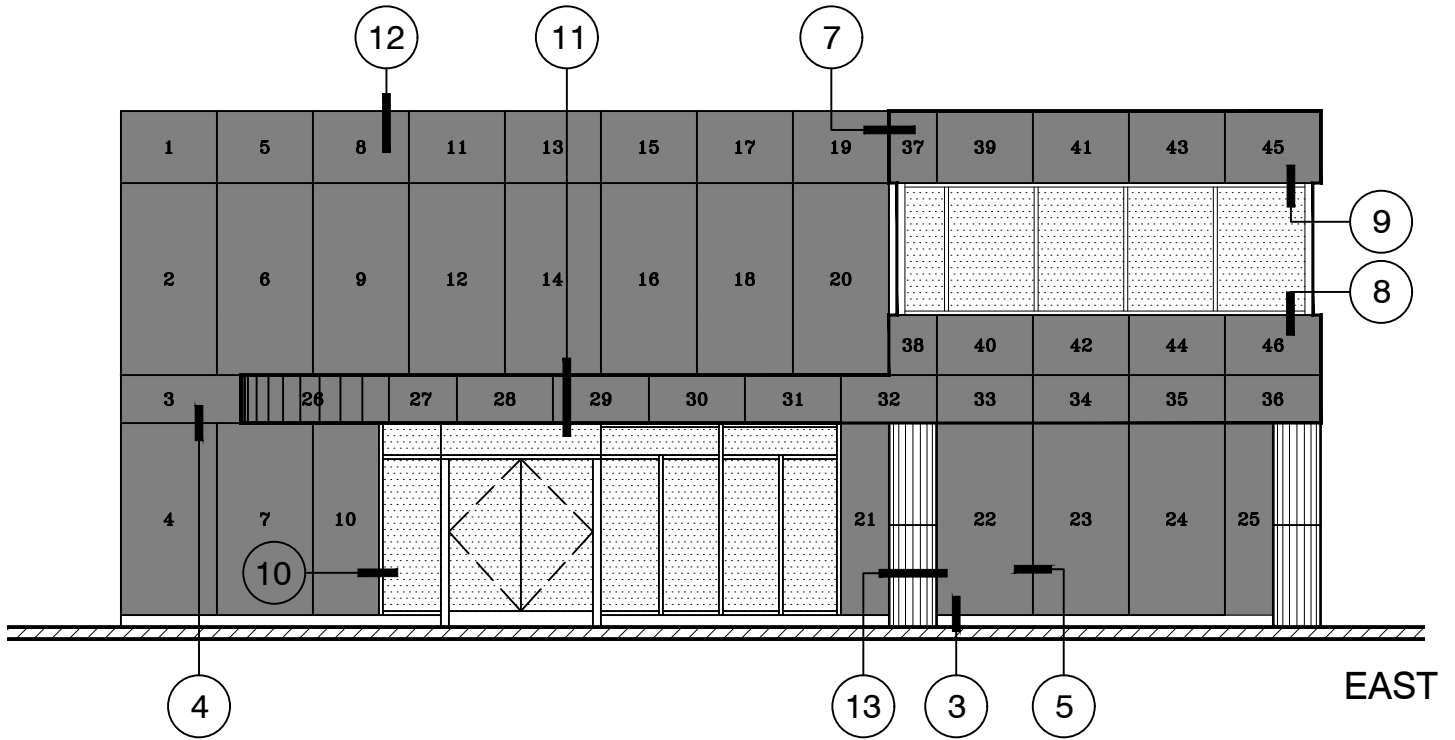

KPS_GENERIC_2_MOD_PC



EAST AND SOUTH ELEVATIONS

1 OF 14

KEITH PANEL SYSTEMS

SYSTEM DETAILS

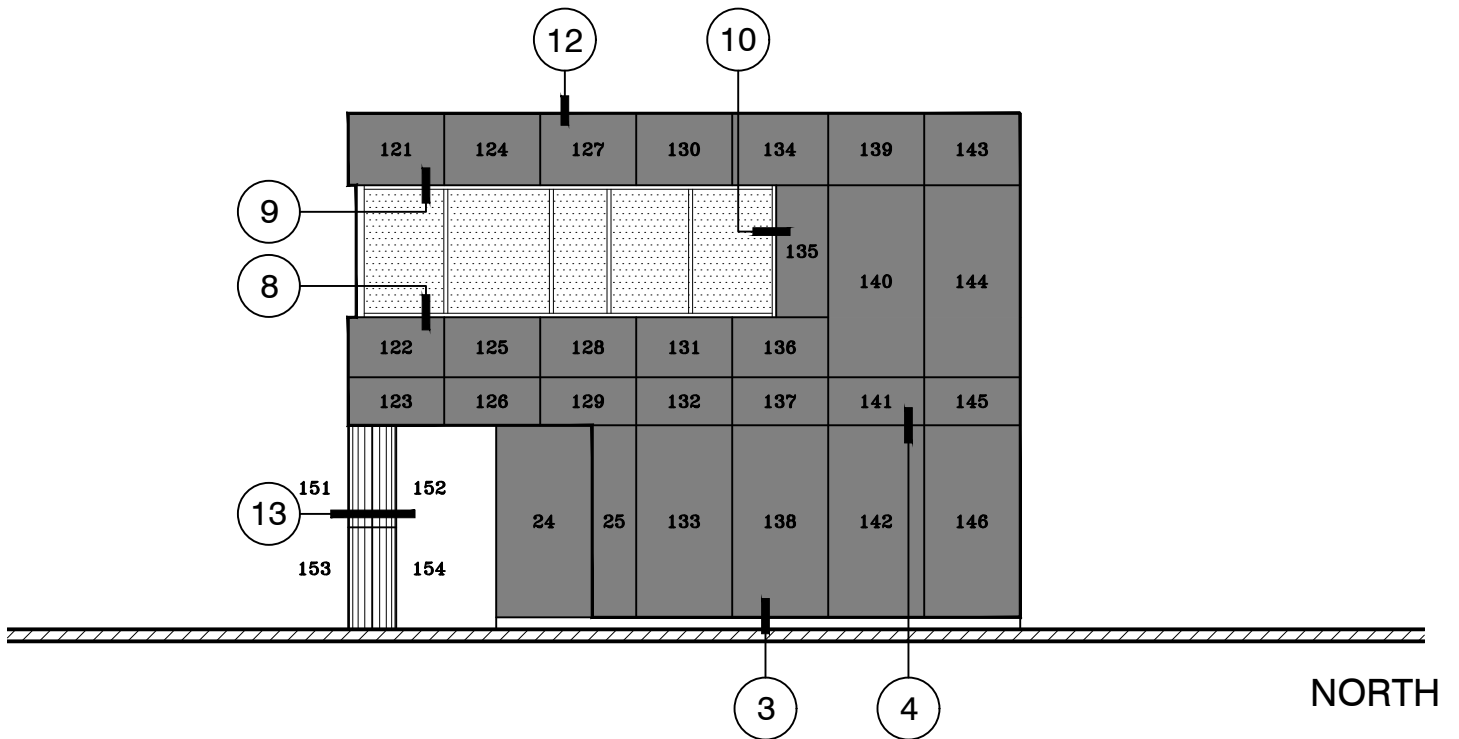
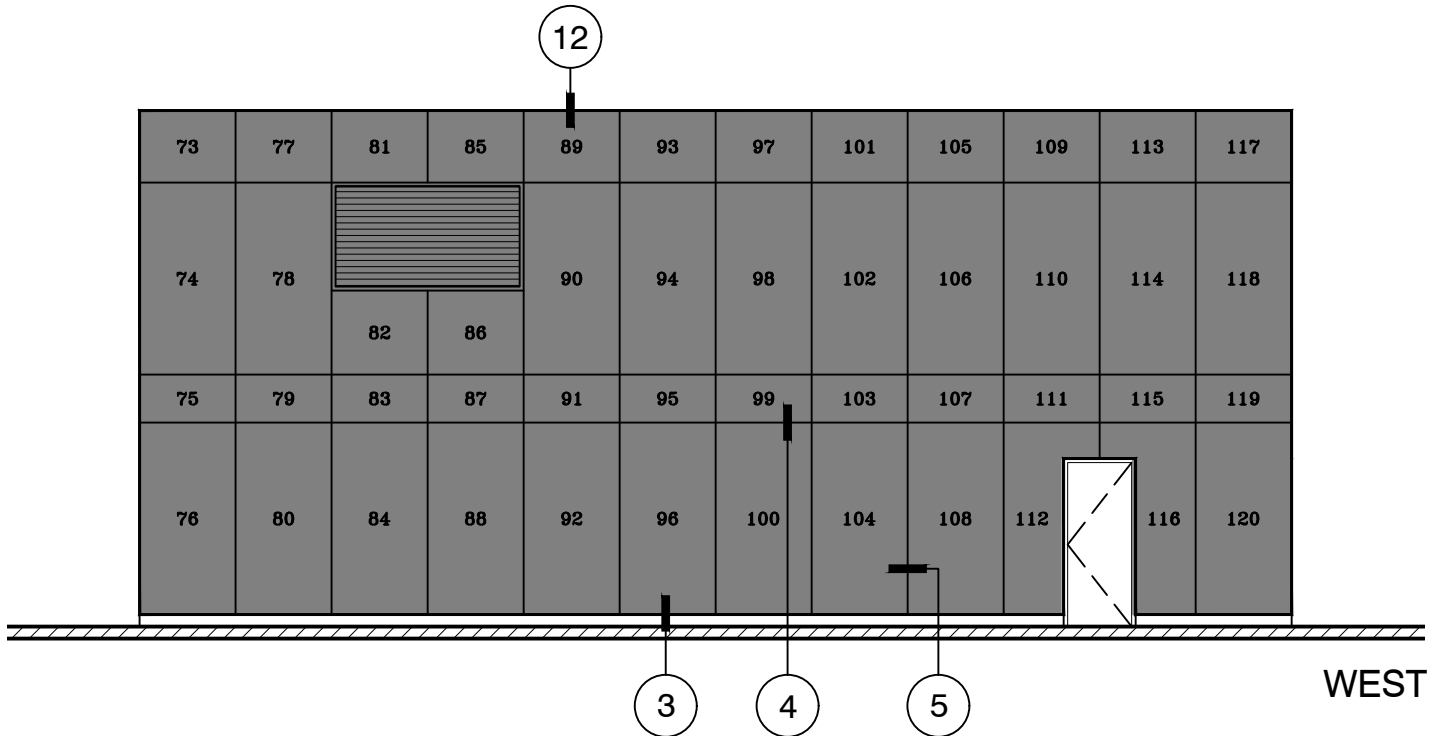

KPS_GENERIC_2_MOD_PC



WEST AND NORTH ELEVATIONS

2 OF 14

KEITH PANEL SYSTEMS

SYSTEM DETAILS

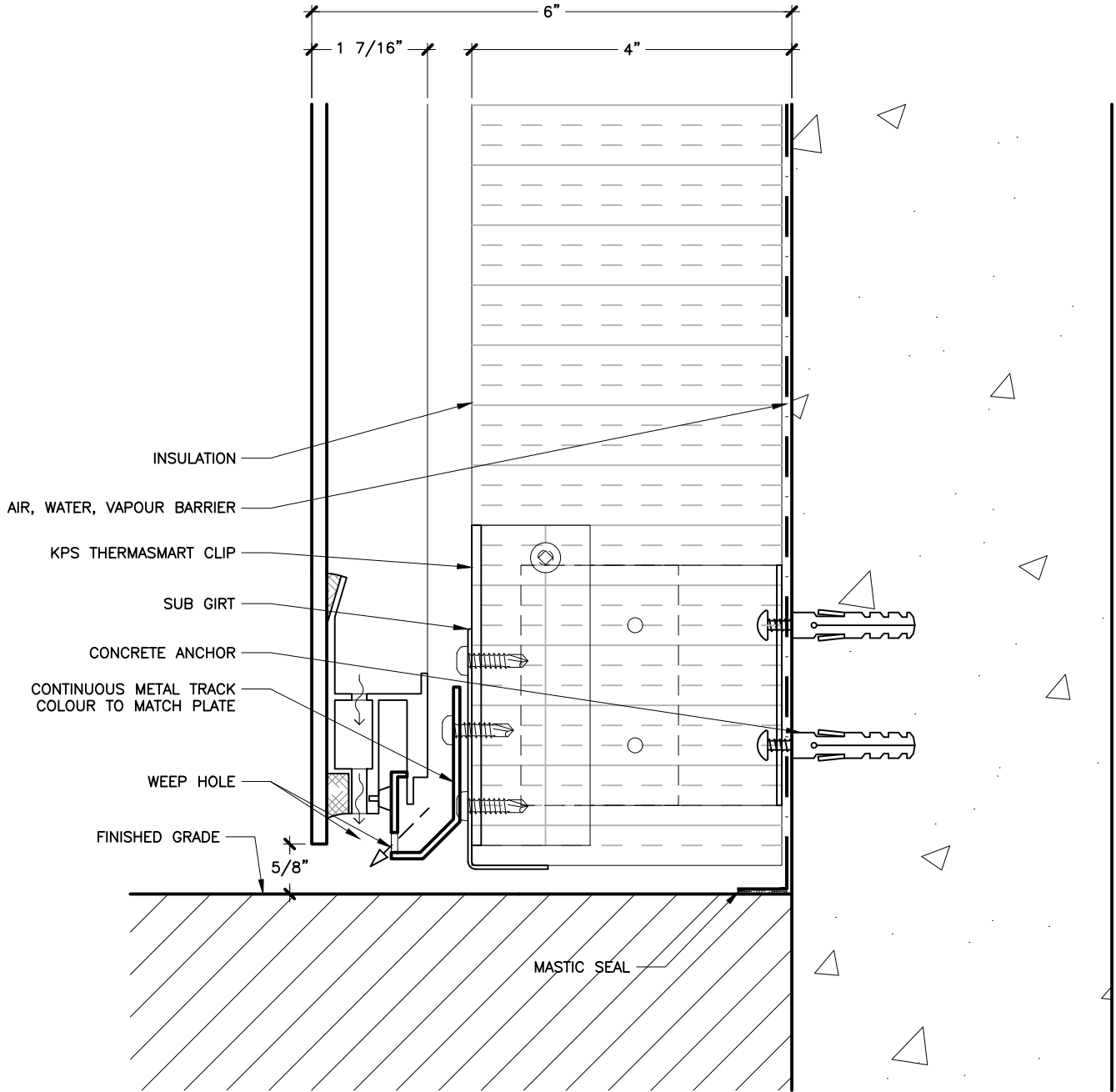

PANEL SILL AT FINISHED GRADE/BALCONY

3 OF 14

KEITH PANEL SYSTEMS

SYSTEM DETAILS

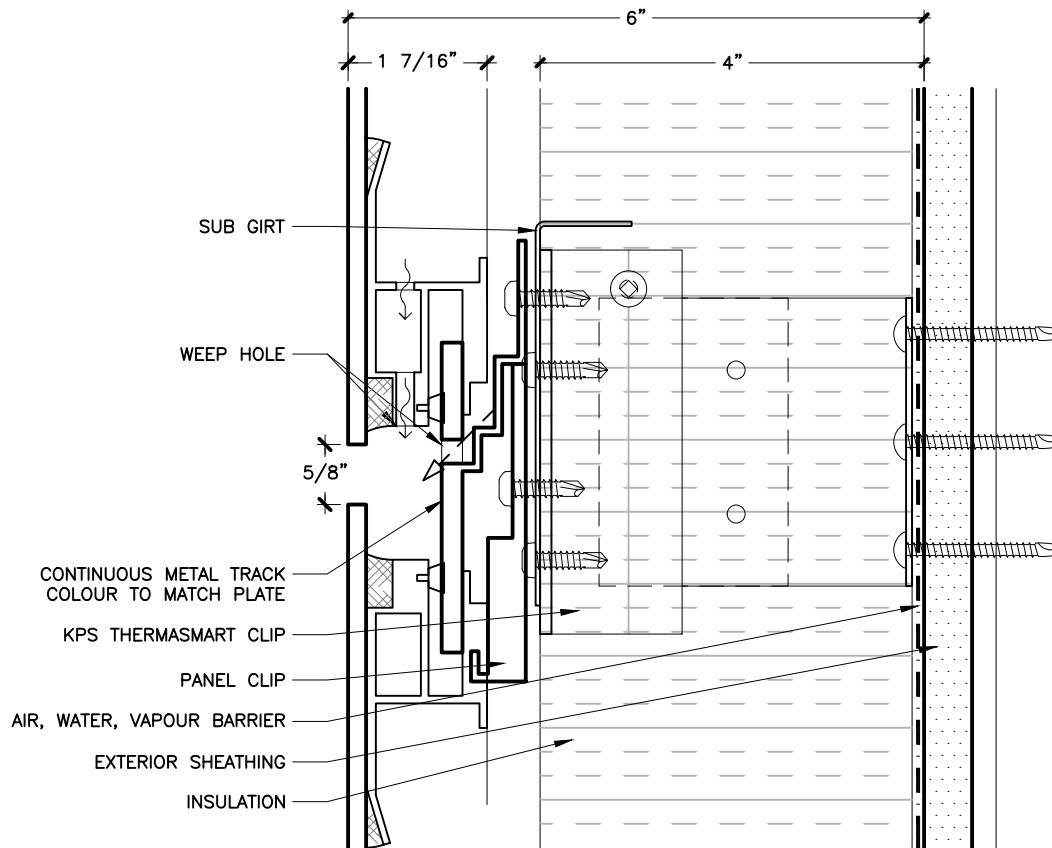

HORIZONTAL JOINT

4 OF 14

KEITH PANEL SYSTEMS

SYSTEM DETAILS

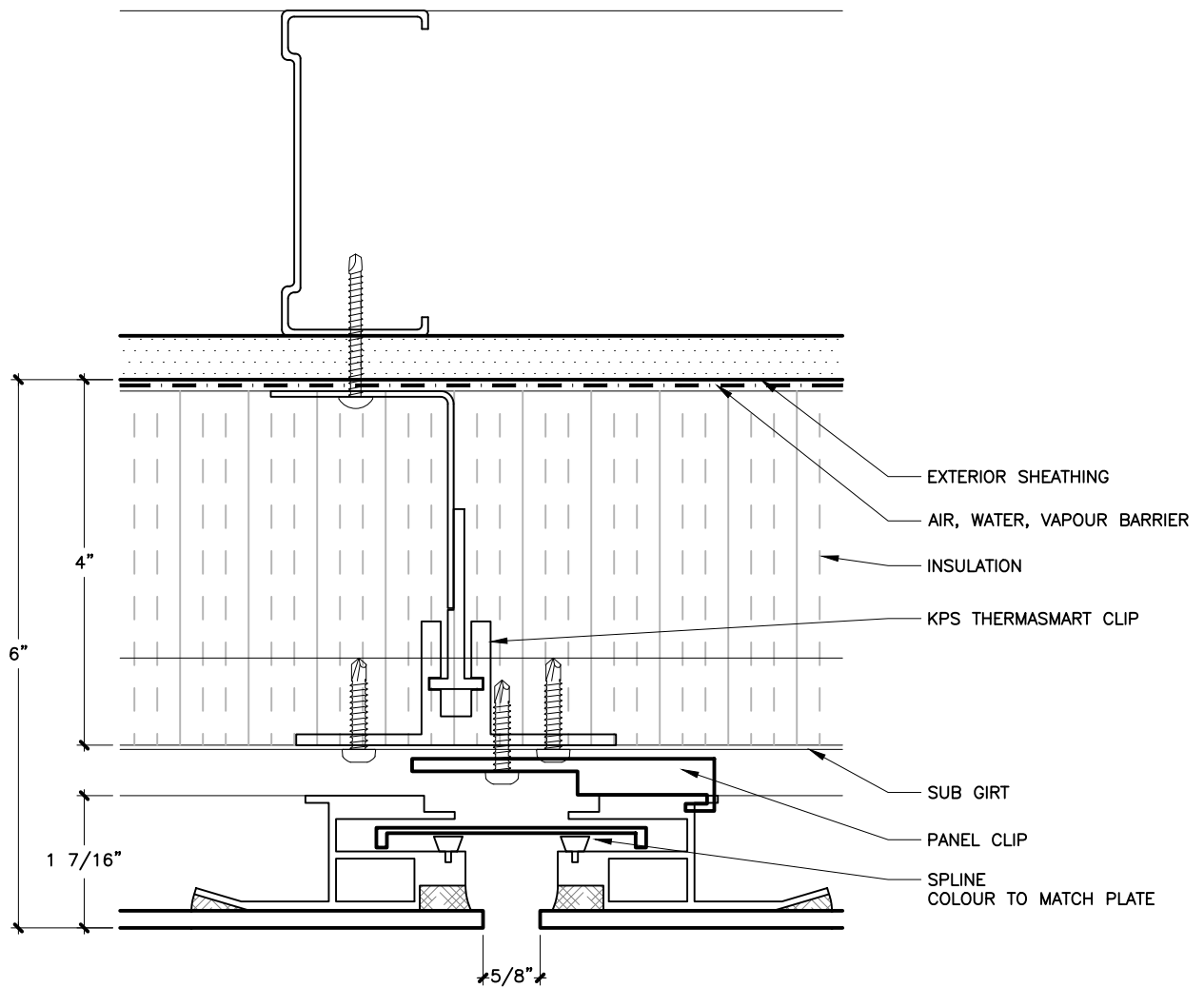

VERTICAL JOINT

5 OF 14

KEITH PANEL SYSTEMS

SYSTEM DETAILS

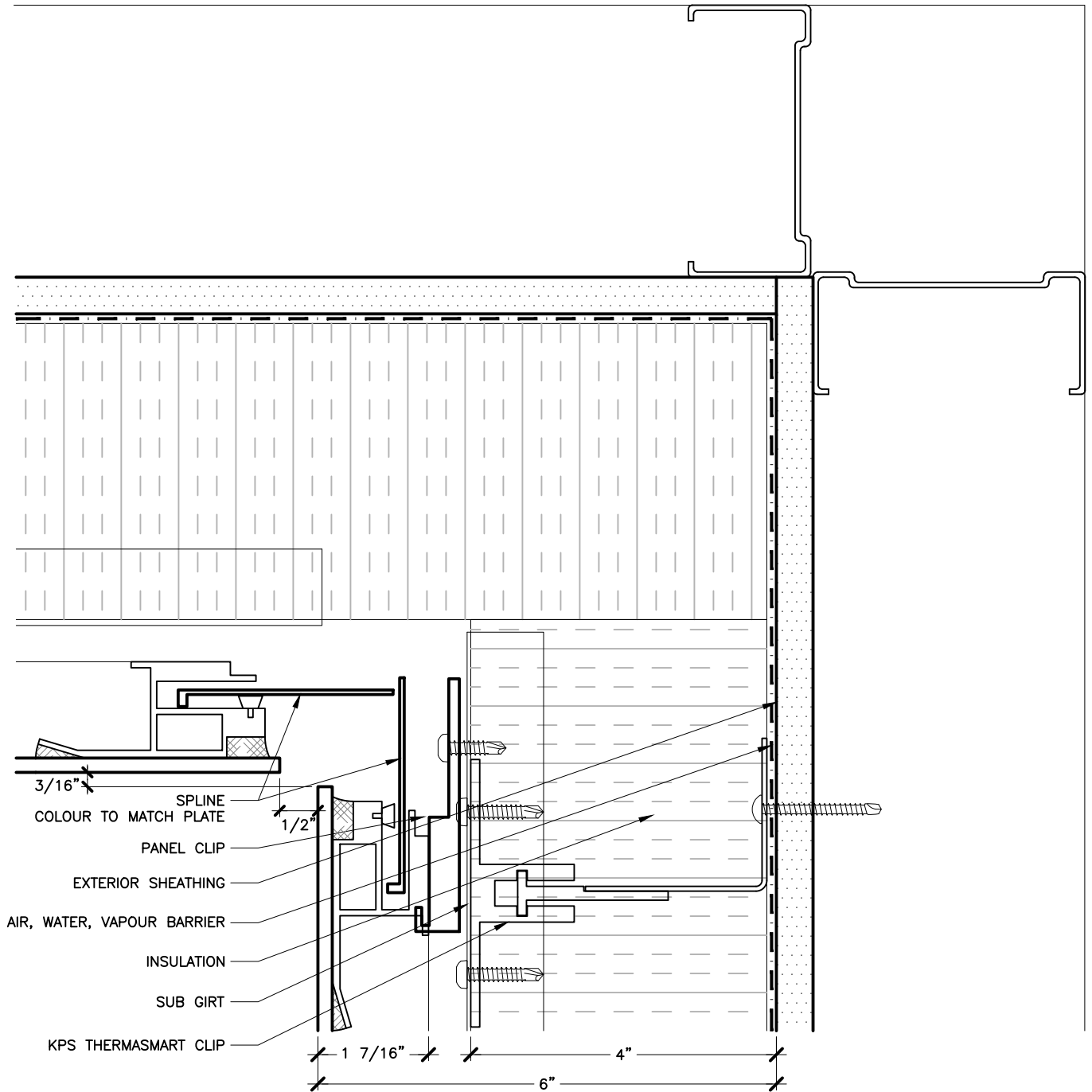

PLAN DETAIL INSIDE CORNER

6 OF 14

KEITH PANEL SYSTEMS

SYSTEM DETAILS

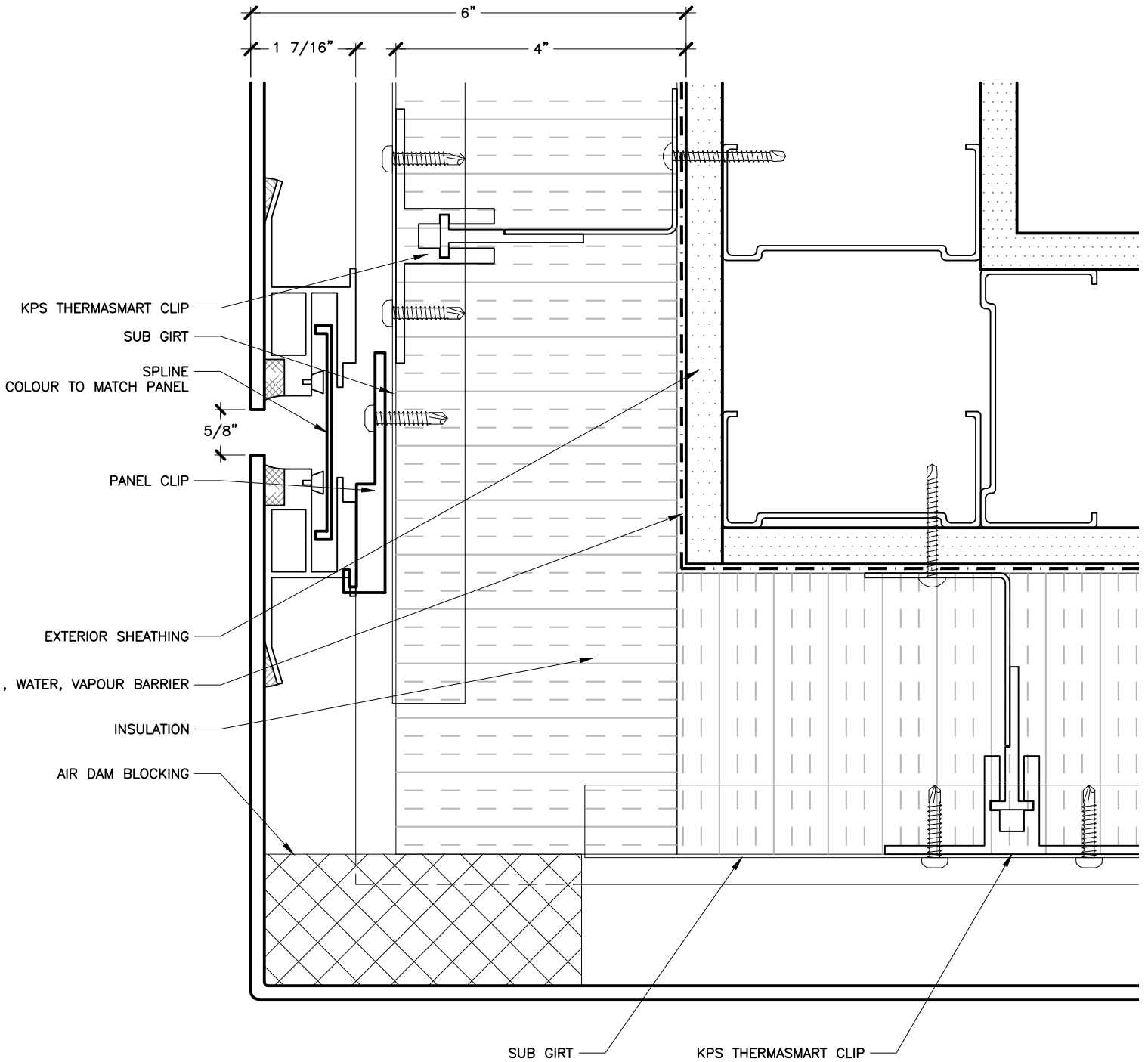

PLAN DETAIL OUTSIDE CORNER

7 OF 14

KEITH PANEL SYSTEMS

SYSTEM DETAILS

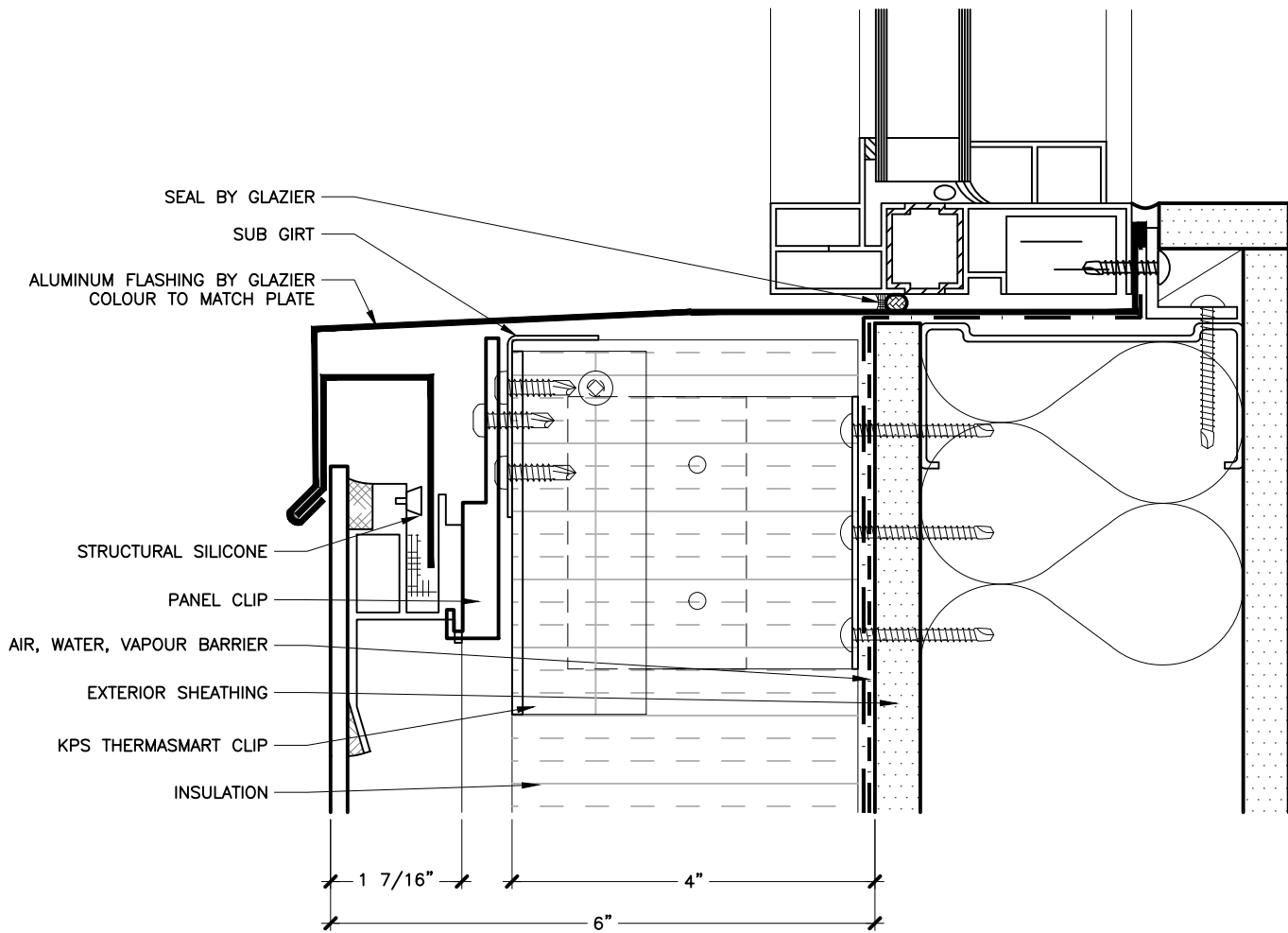

WINDOW SILL

8 OF 14

KEITH PANEL SYSTEMS

SYSTEM DETAILS

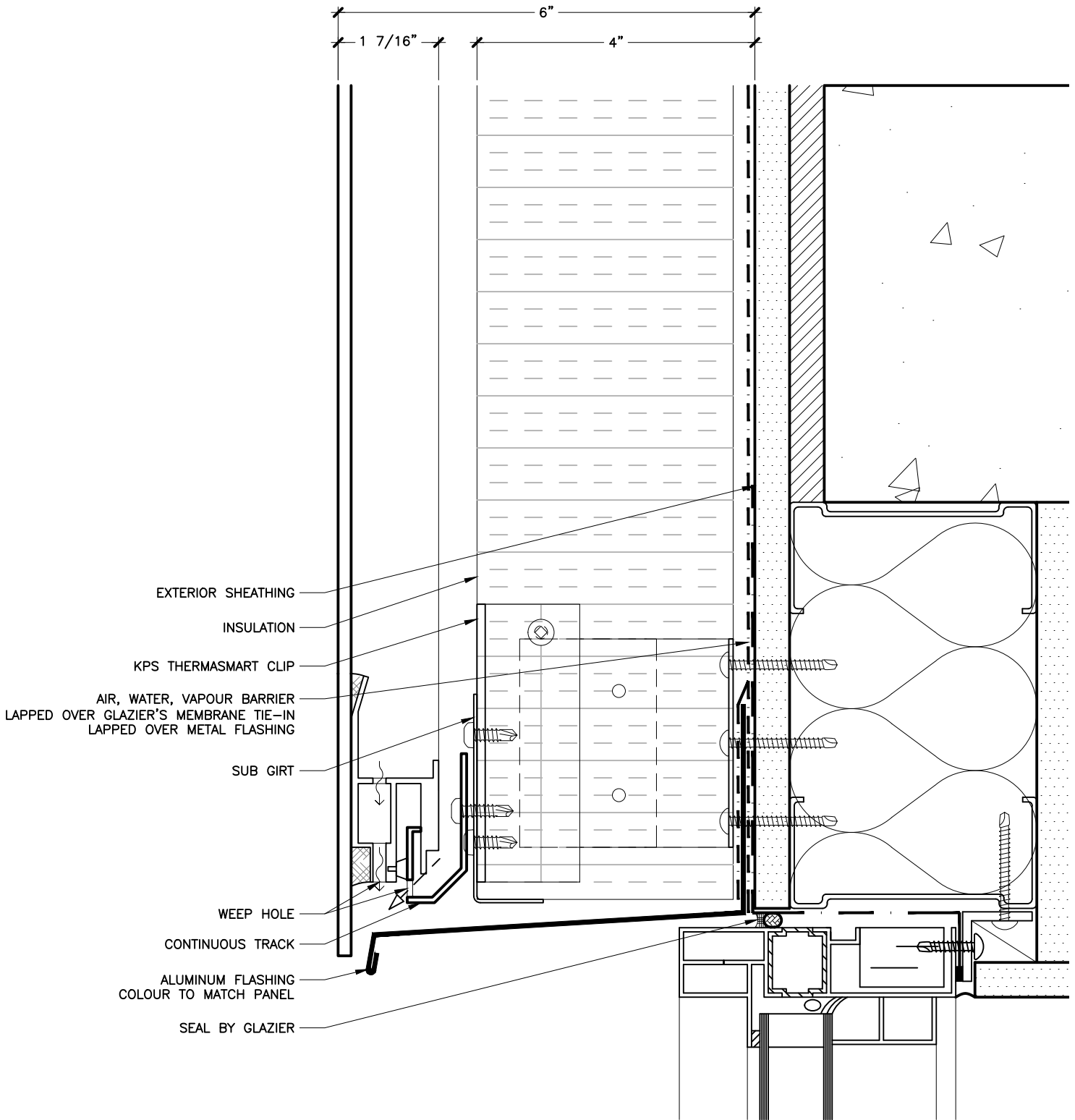

WINDOW HEAD

9 OF 14

KEITH PANEL SYSTEMS

SYSTEM DETAILS

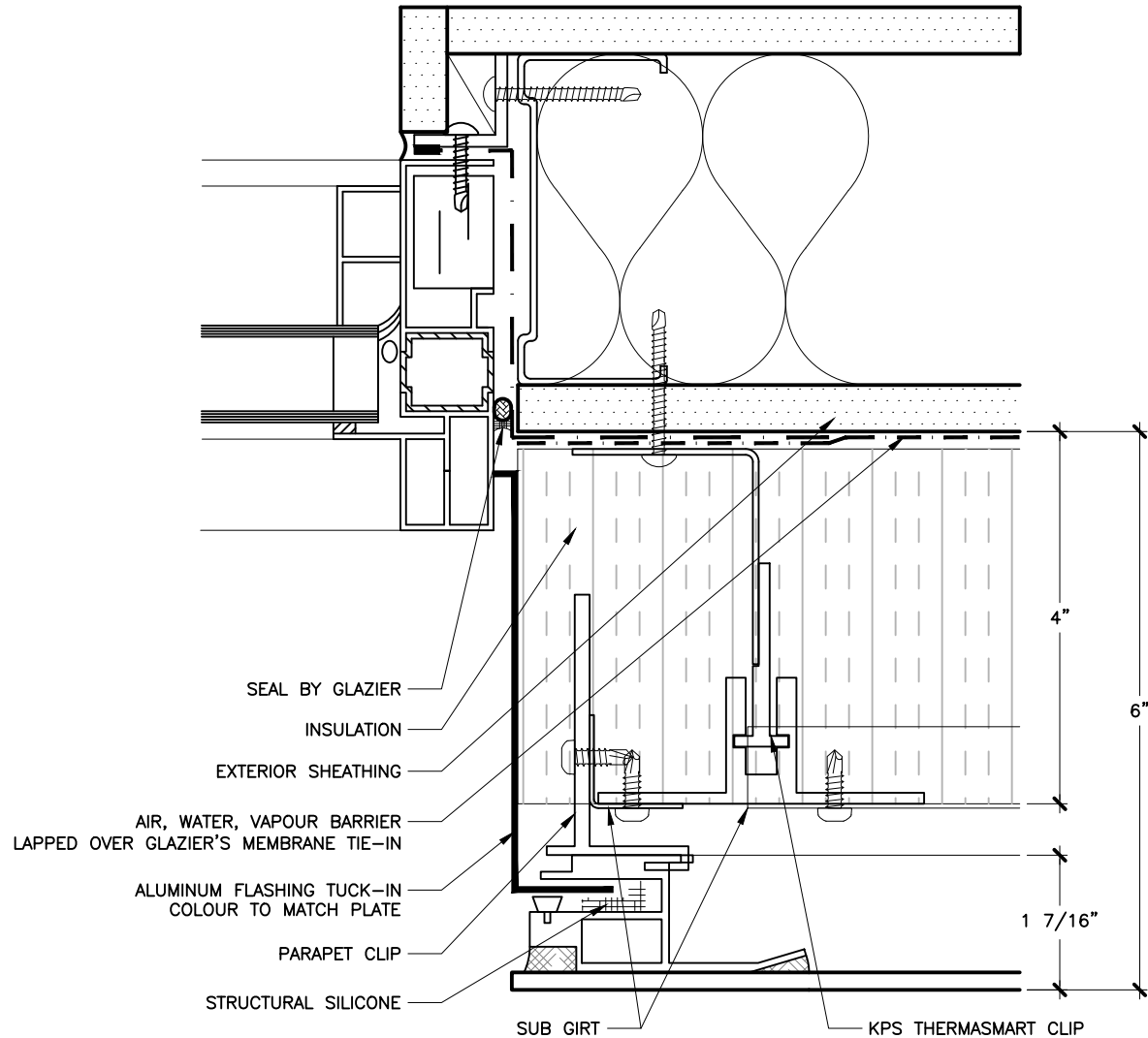

WINDOW JAMB

10 OF 14

KEITH PANEL SYSTEMS

SYSTEM DETAILS

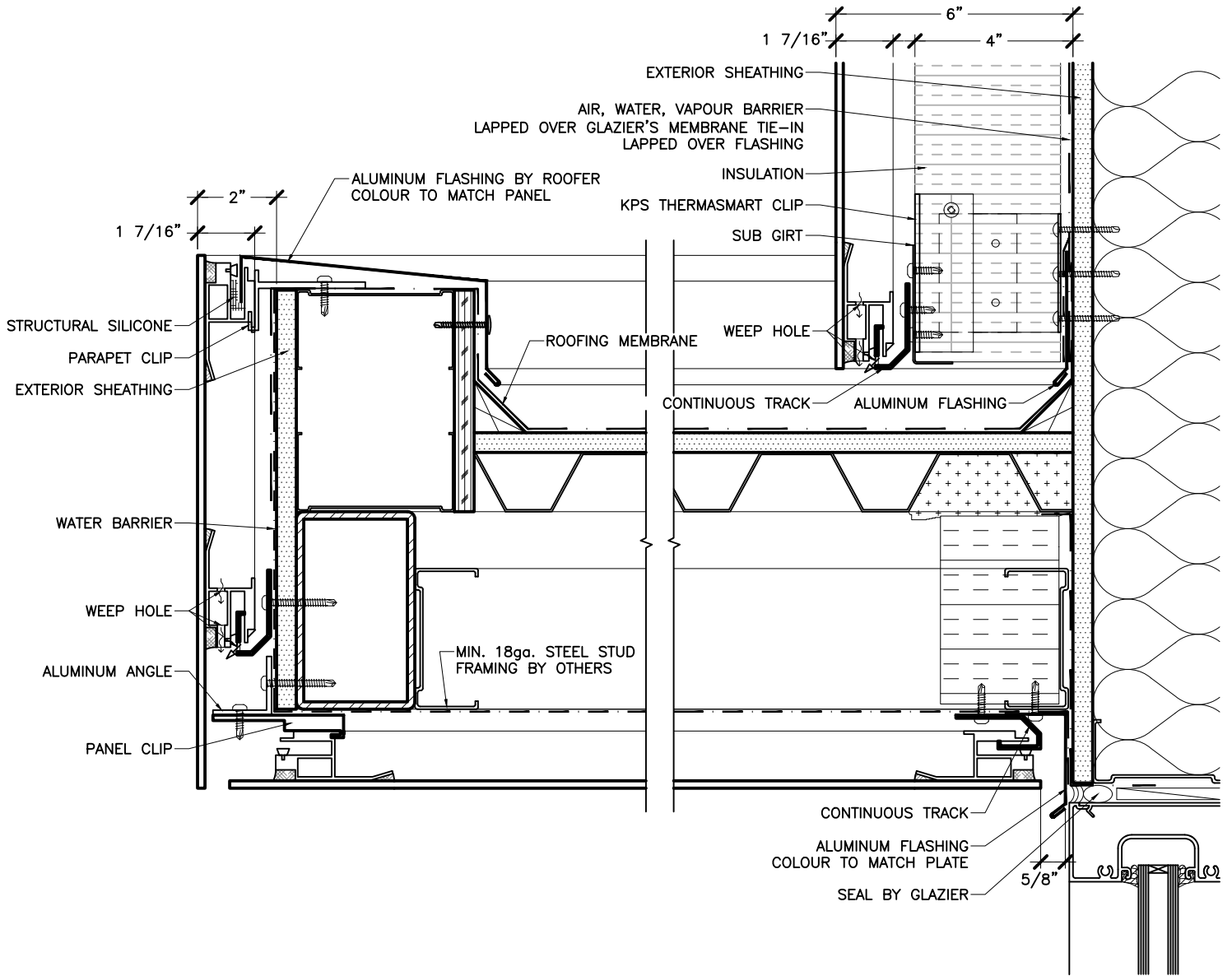

PARAPET SECTION DETAIL

11 OF 14

KEITH PANEL SYSTEMS

SYSTEM DETAILS

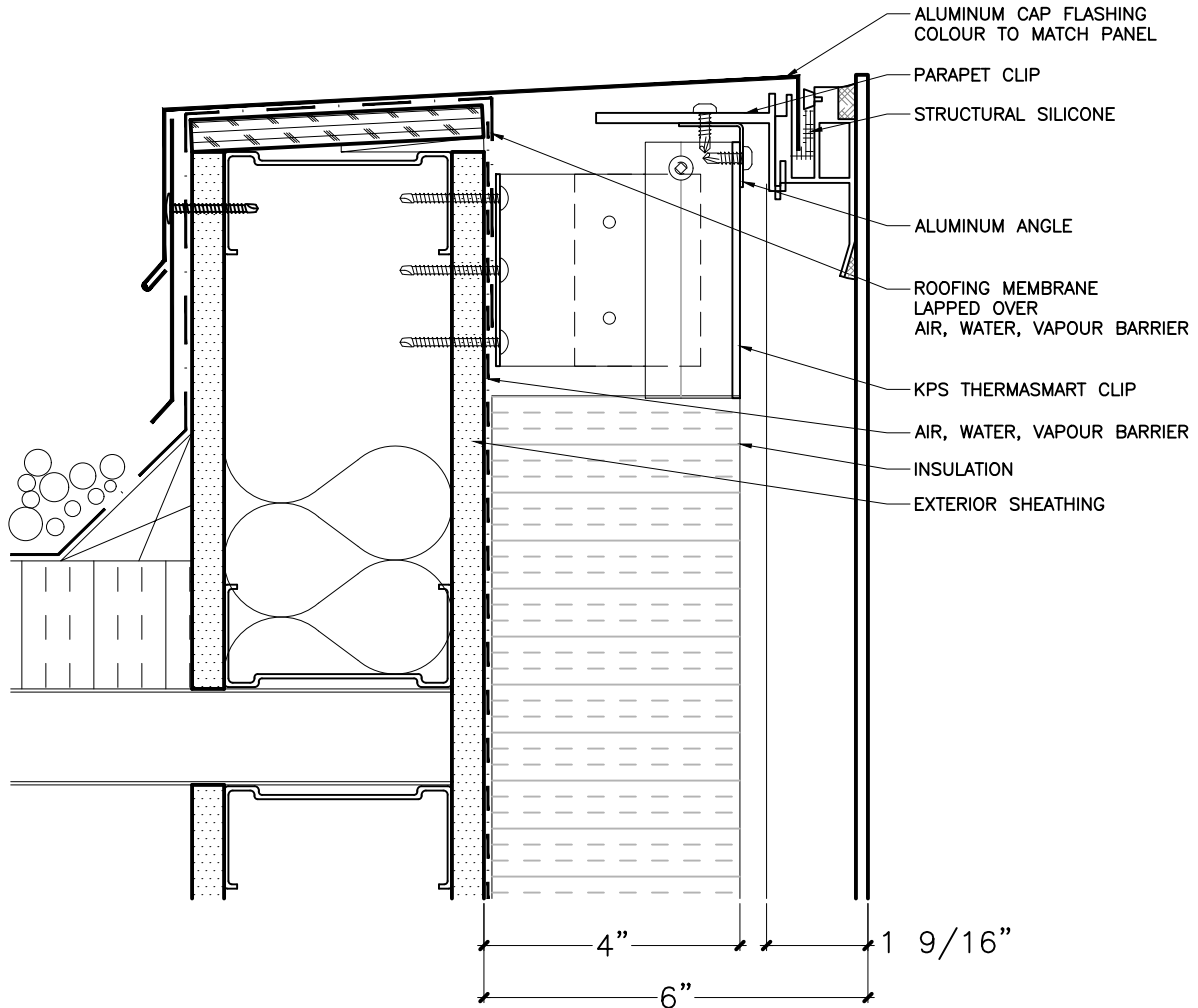

PARAPET SECTION DETAIL

12 OF 14

KEITH PANEL SYSTEMS

SYSTEM DETAILS

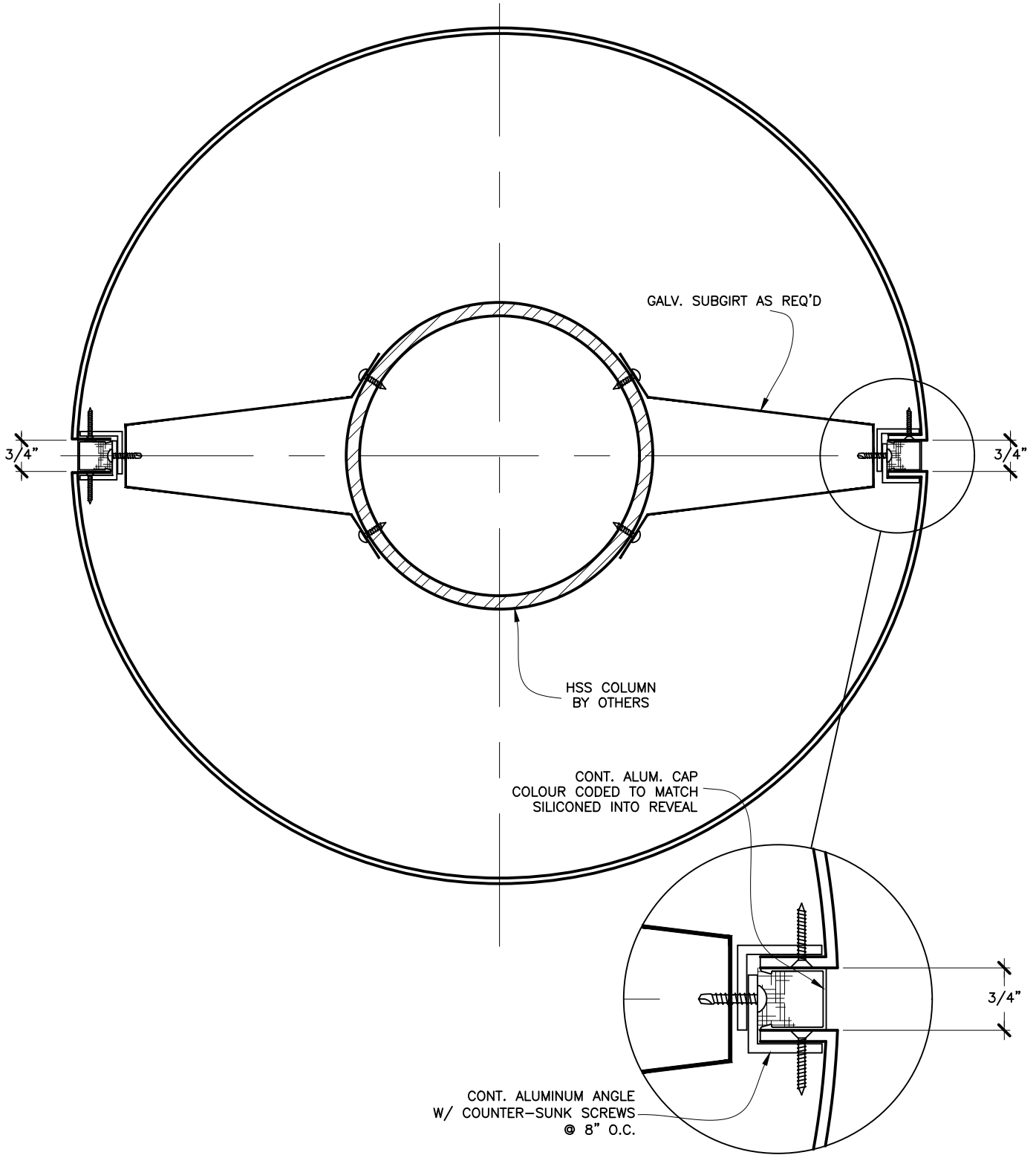

ROUND COLUMN COVERS PLAN DETAIL

KEITH PANEL SYSTEMS

SYSTEM DETAILS

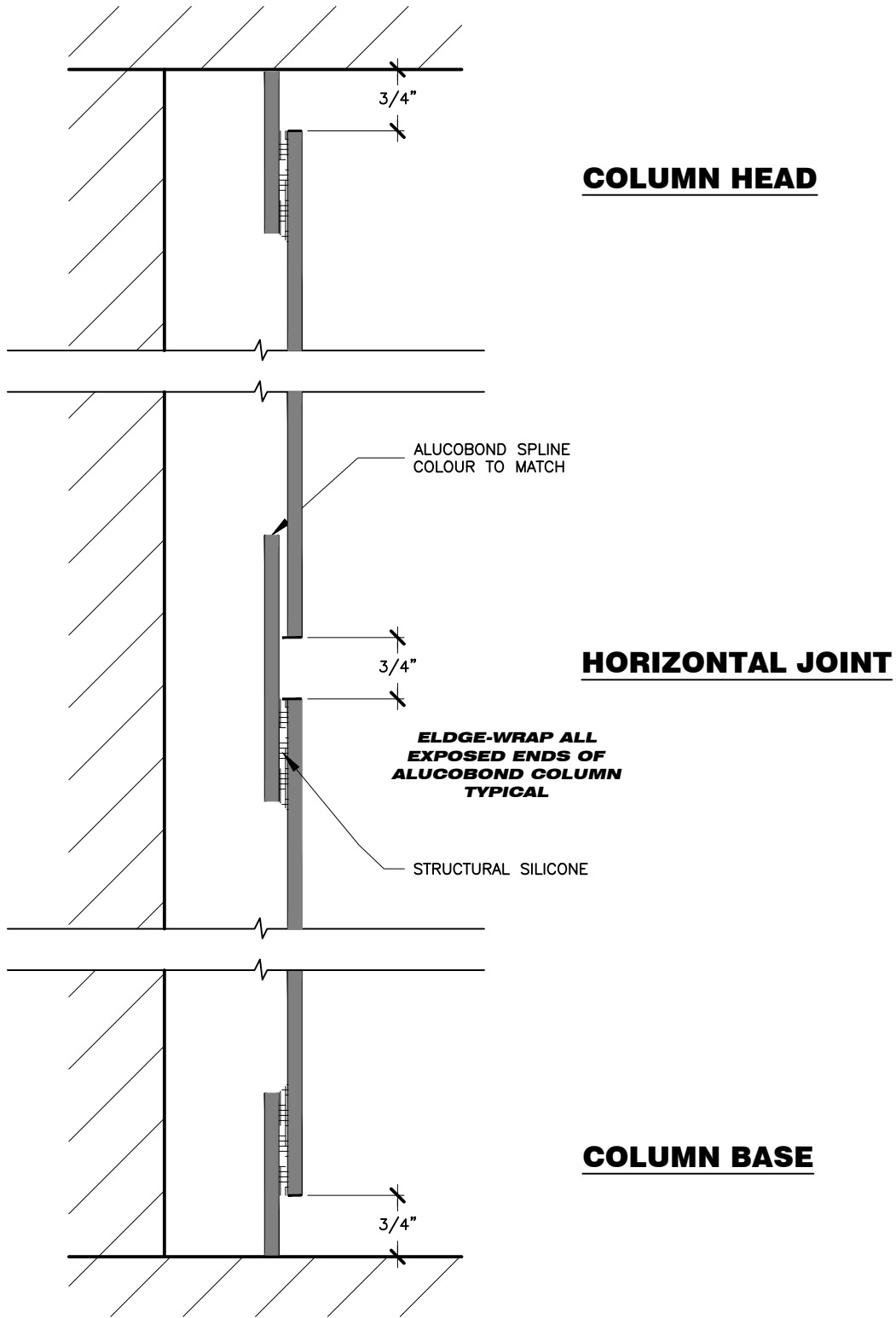

ROUND COLUMN COVERS SECTION DETAILS

14 OF 14